

Series: GP
General Purpose
Industrial Control Transformer

Power Rating: **25VA**

- UL/cUL 5085-2 Listed File E47299, CE marked.
- UL 1446 Recognized Class B 130°C Insulation System File E95662
- 50/60Hz Operation
- No Fuse on Primary and Secondary Side
- European Style Touch-Proof Terminals.



FRONT VIEW

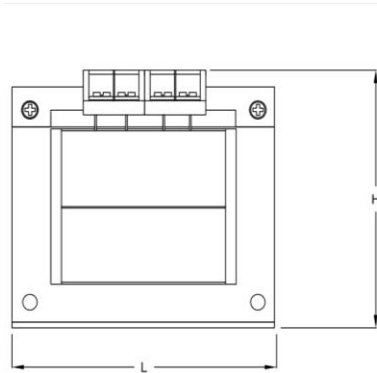

SIDE VIEW

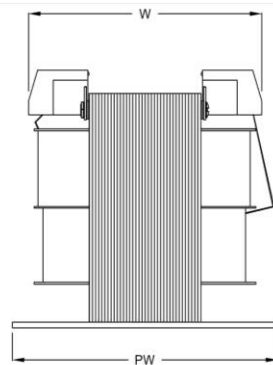

TOP VIEW

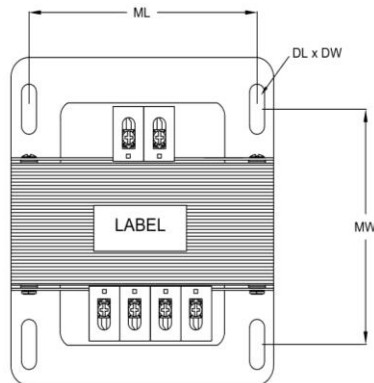

DIMENSIONS	
L	3.000"
W	3.300"
H	3.000"
ML	2.500"
MW	2.000"
PW	2.840"
DL x DW	0.437"x0.203"

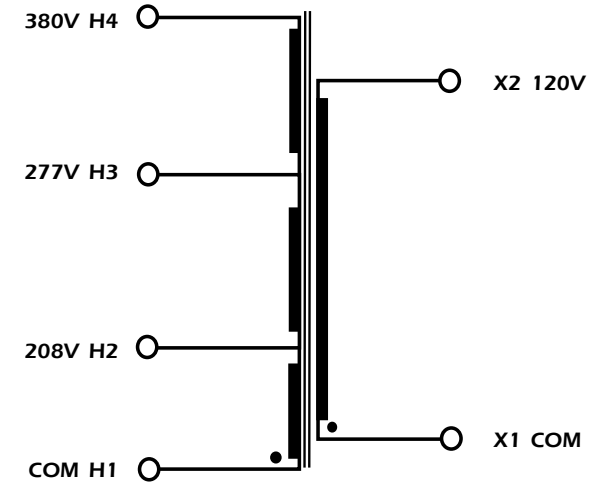

		<p>The Power for your System</p>	300 W Factory Road Addison, IL 60101 USA TEL: 630-628-9999 FAX: 630-628-9922 www.powervolt.com
		DESCRIPTION: General Purpose Industrial Transformers 208,277,380V 50/60Hz 120V 25VA	
0	4-Mar-2020	MODEL: GP0025-H00	
REV	DATE		